

Варианты для выполнения работы №3 «Построение ступенчатого разреза»

Вариант 1

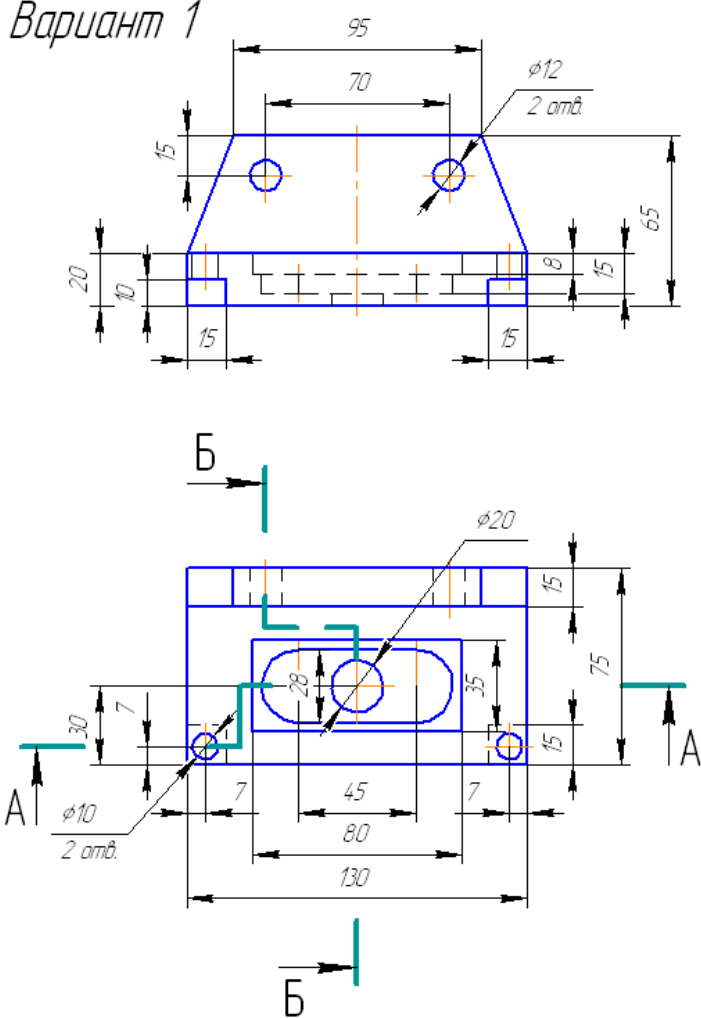

Вариант 2

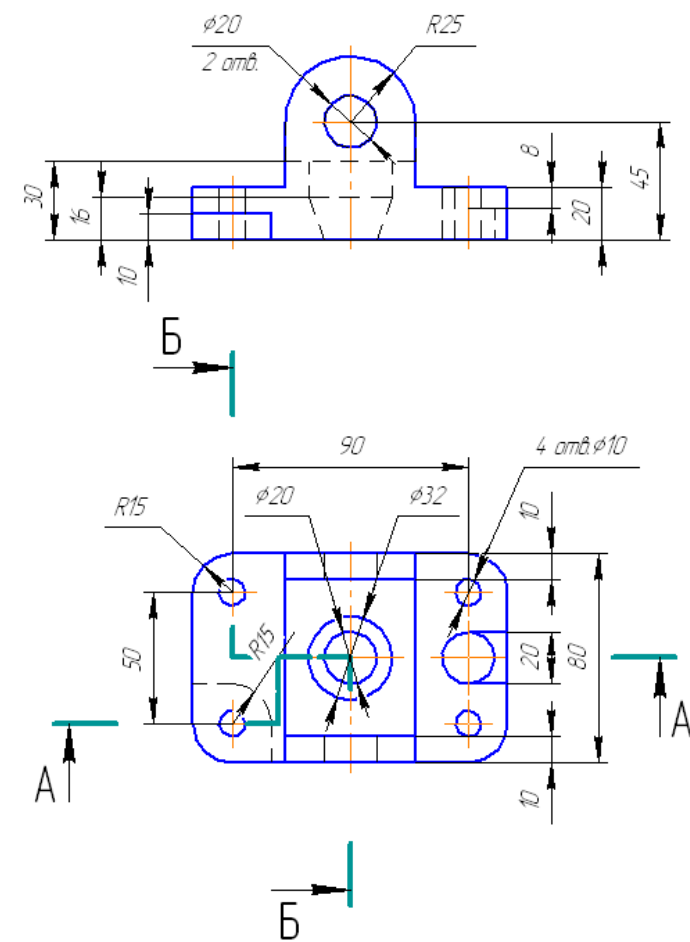

Вариант 3

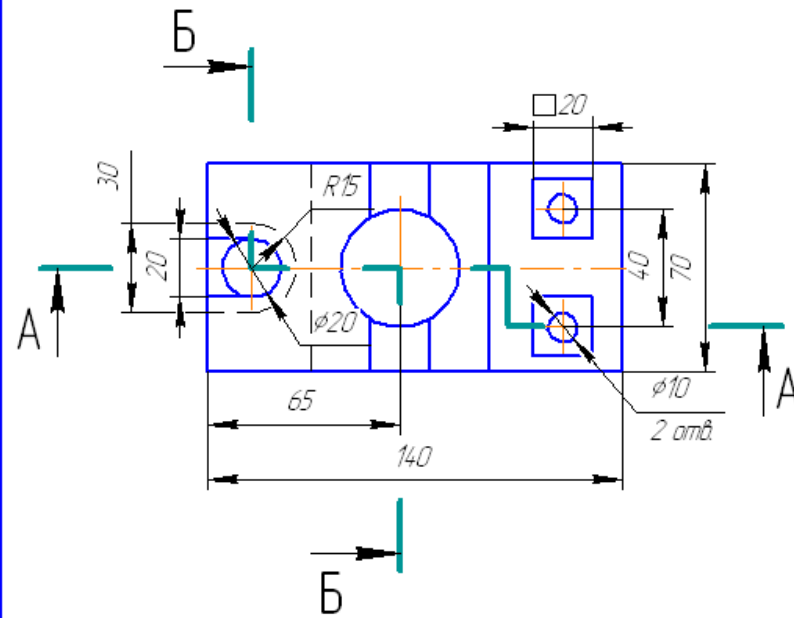
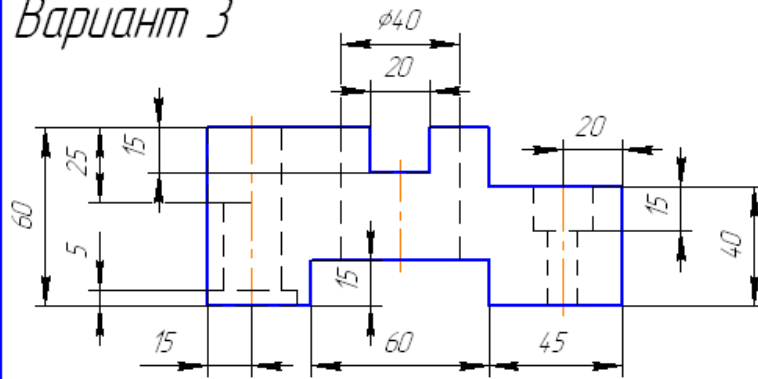

Вариант 4

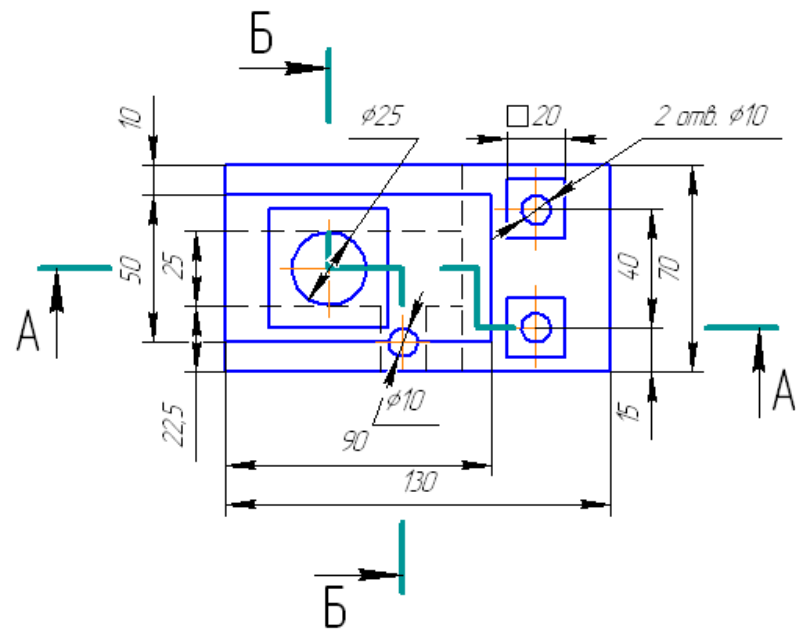
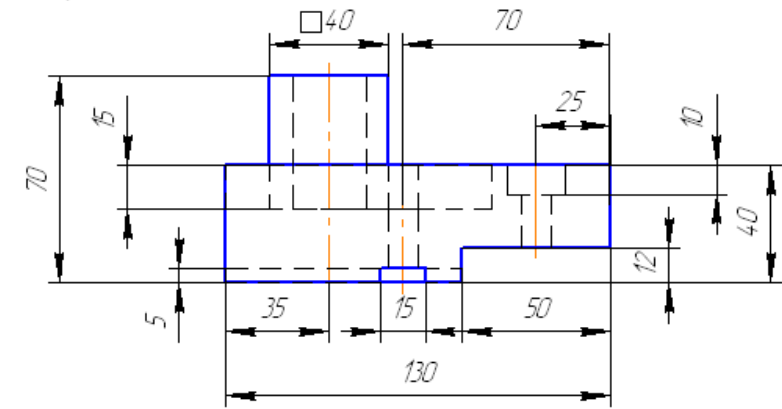

Вариант 5

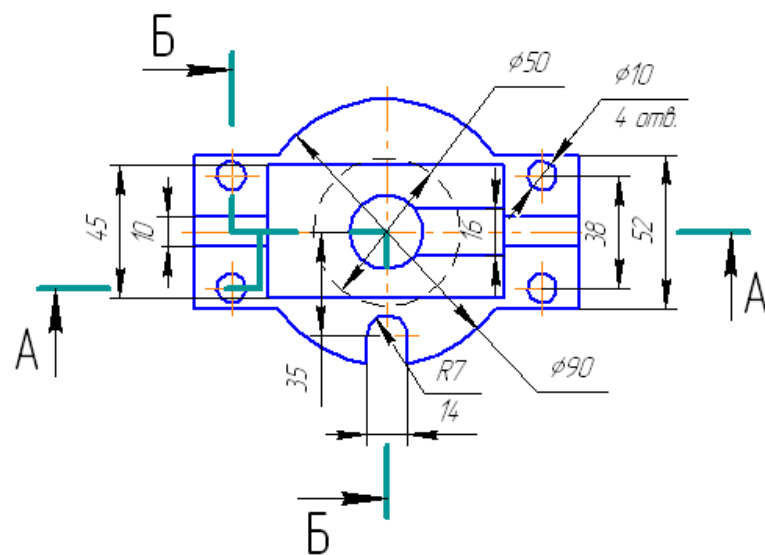
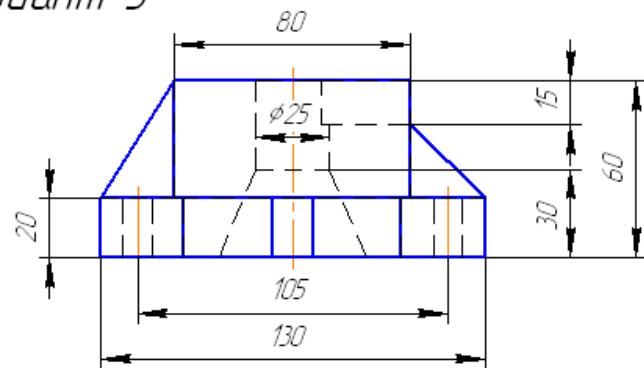

Вариант 6

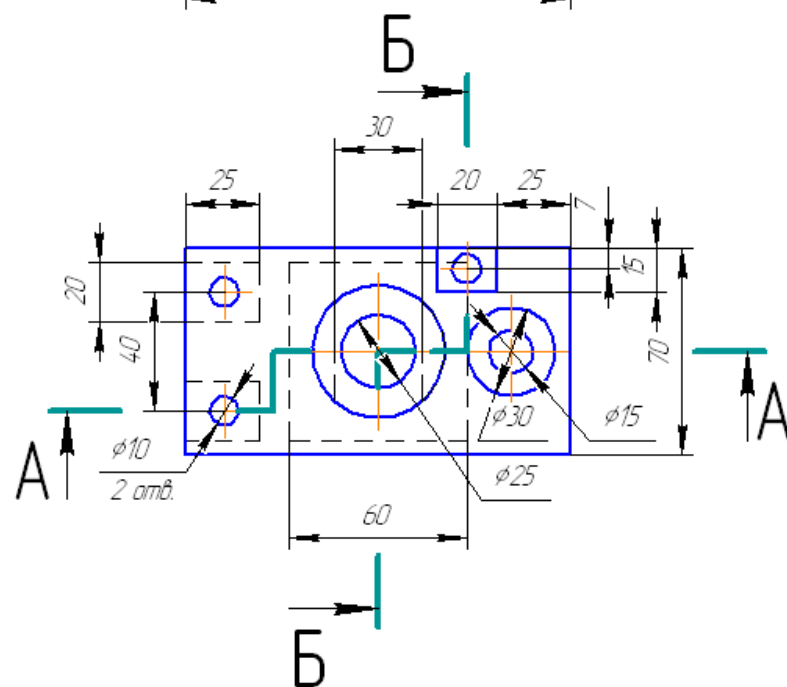
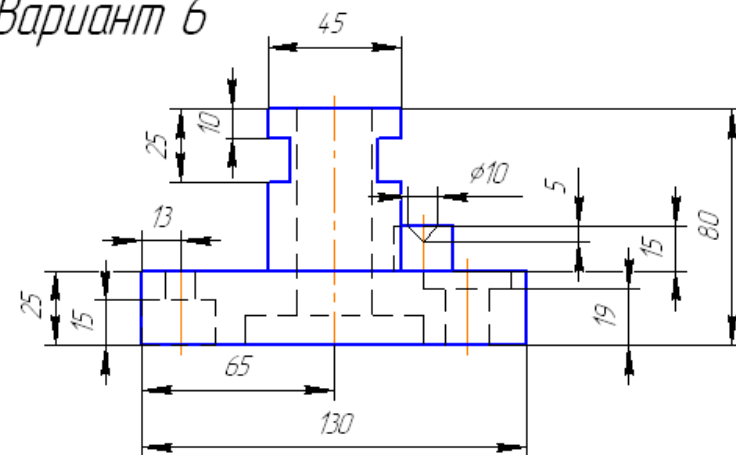

Вариант 7

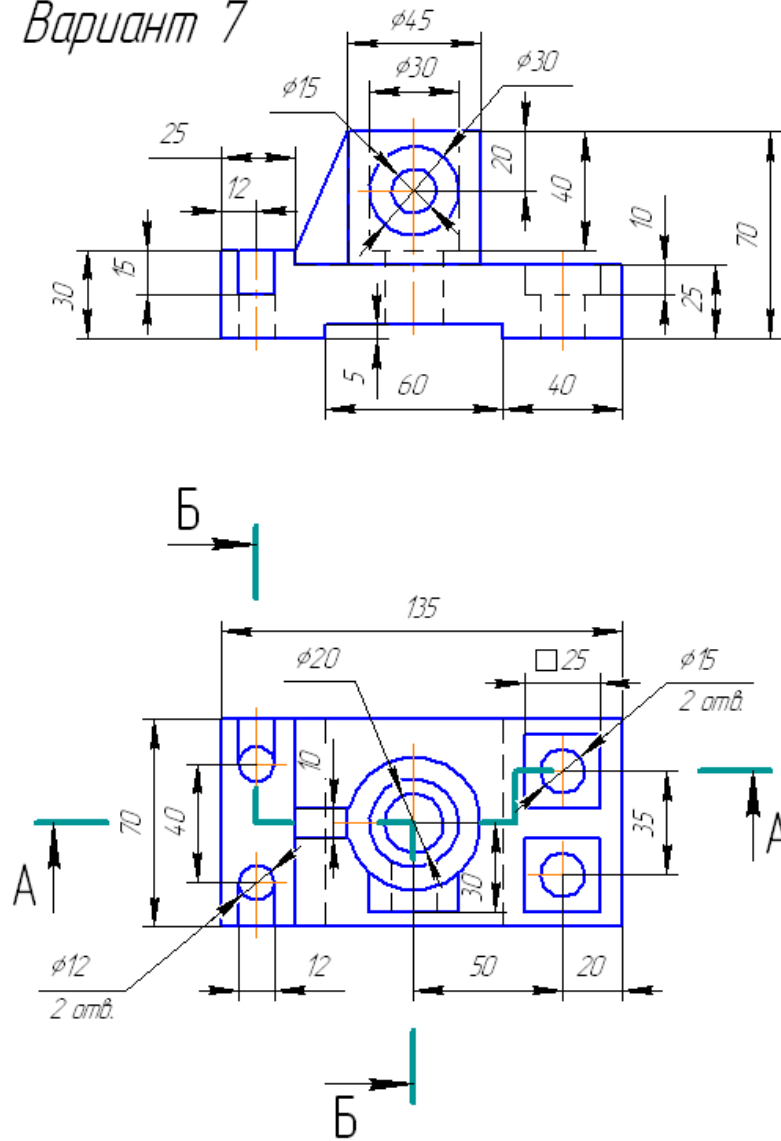

Вариант 8

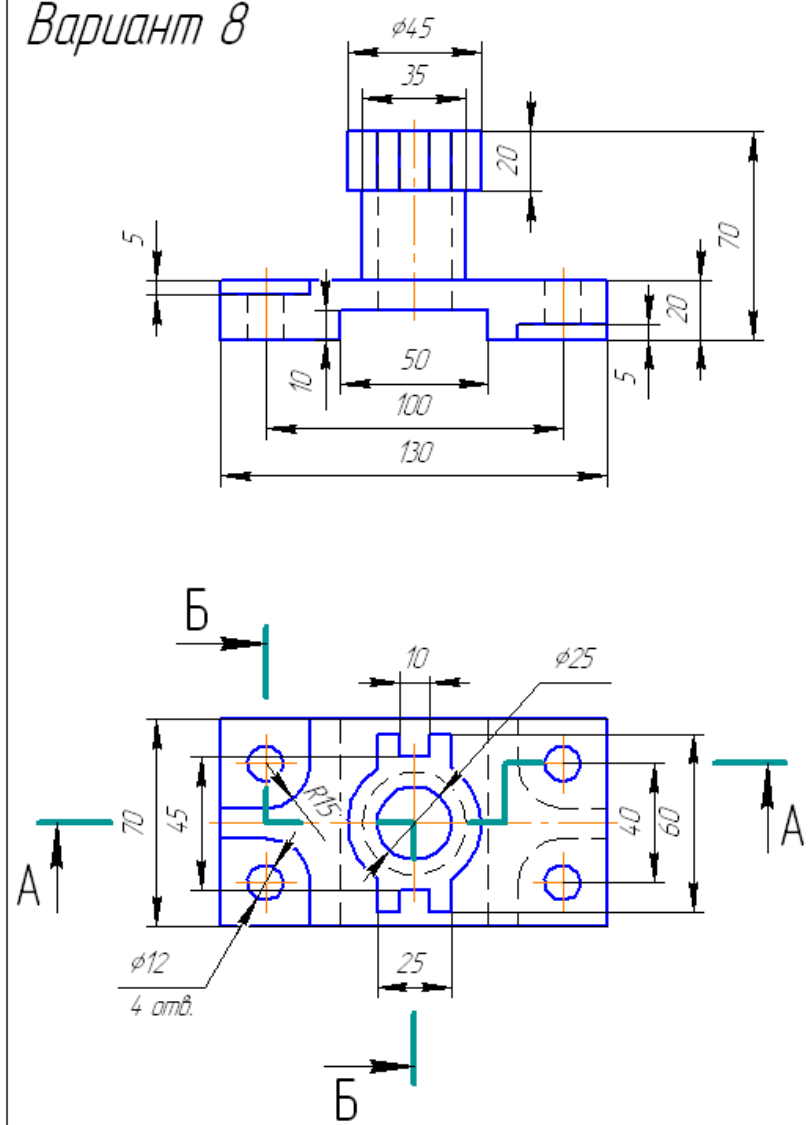

Вариант 9

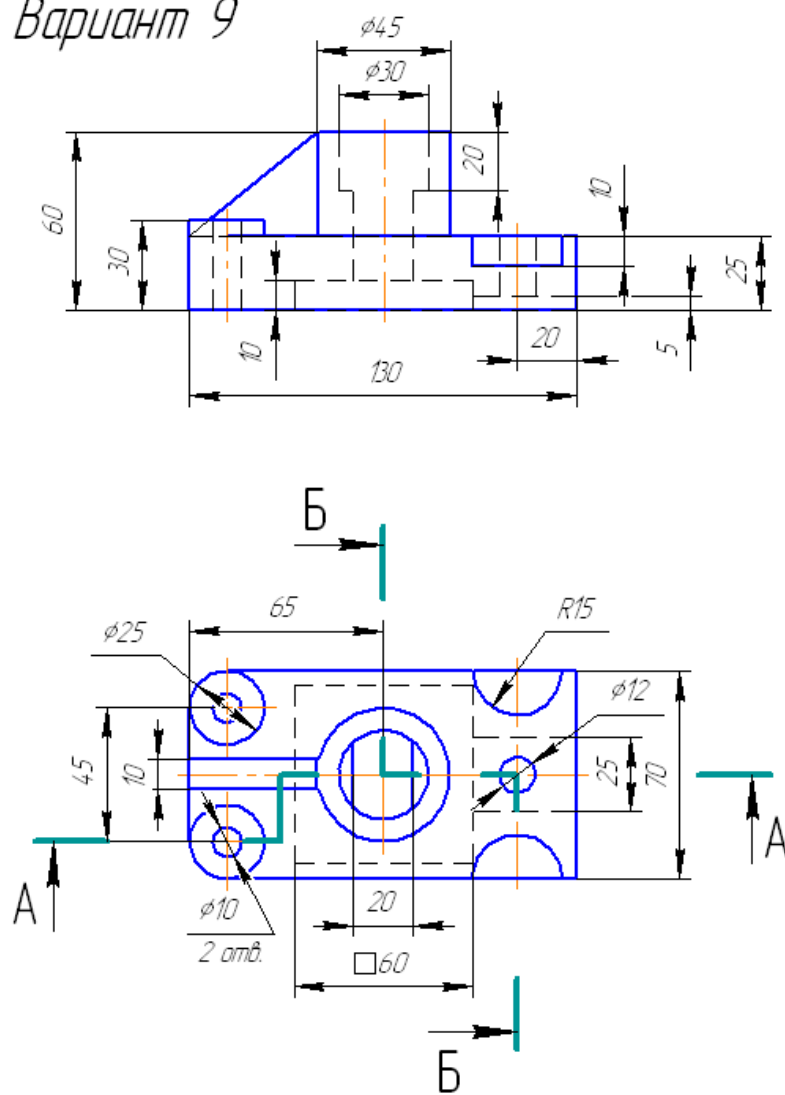

Вариант 10

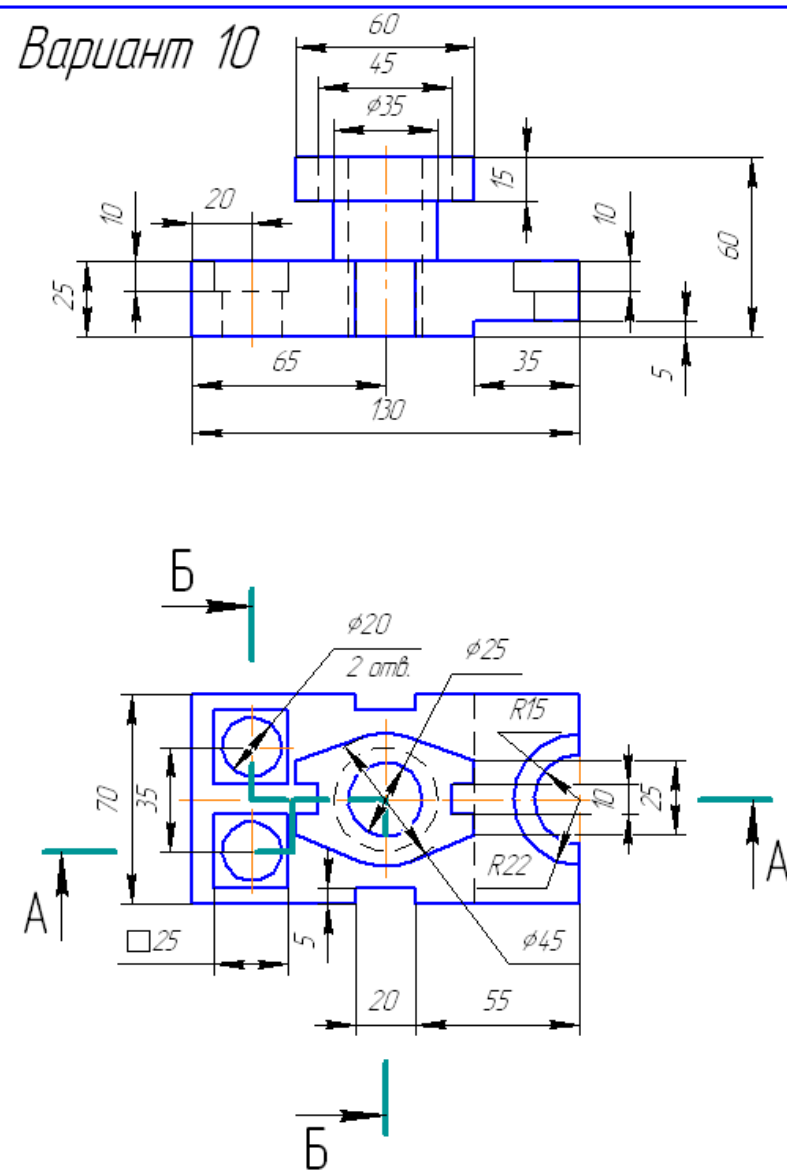

Вариант 13

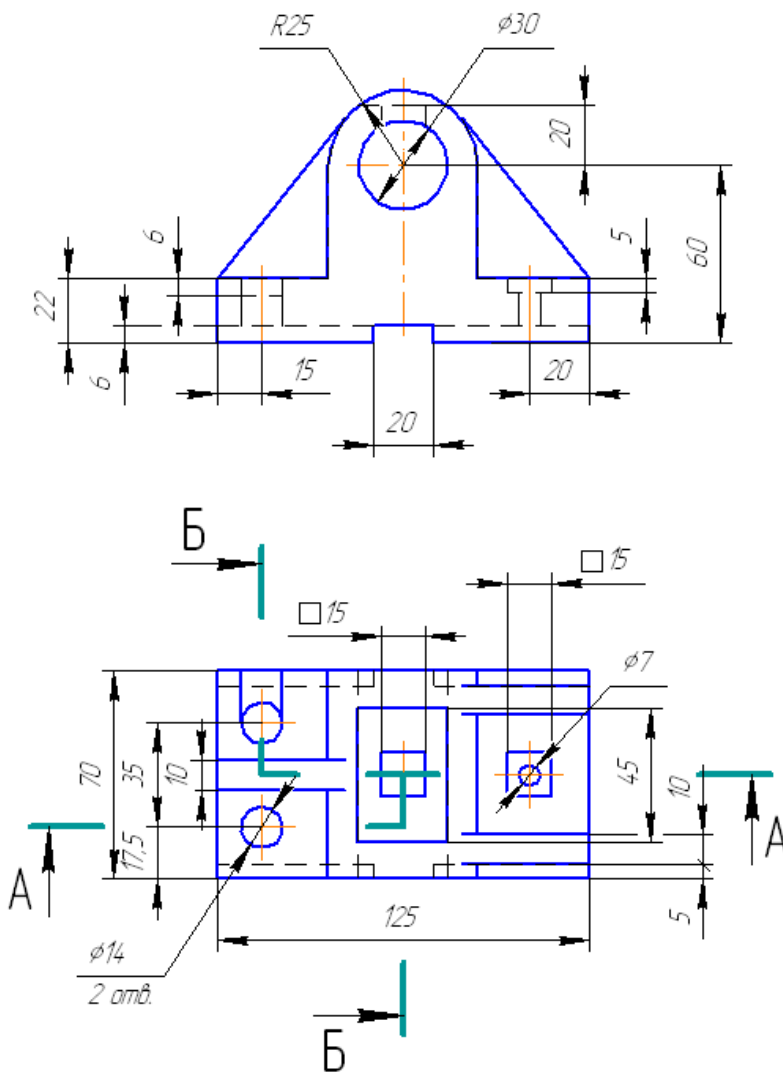

Вариант 14

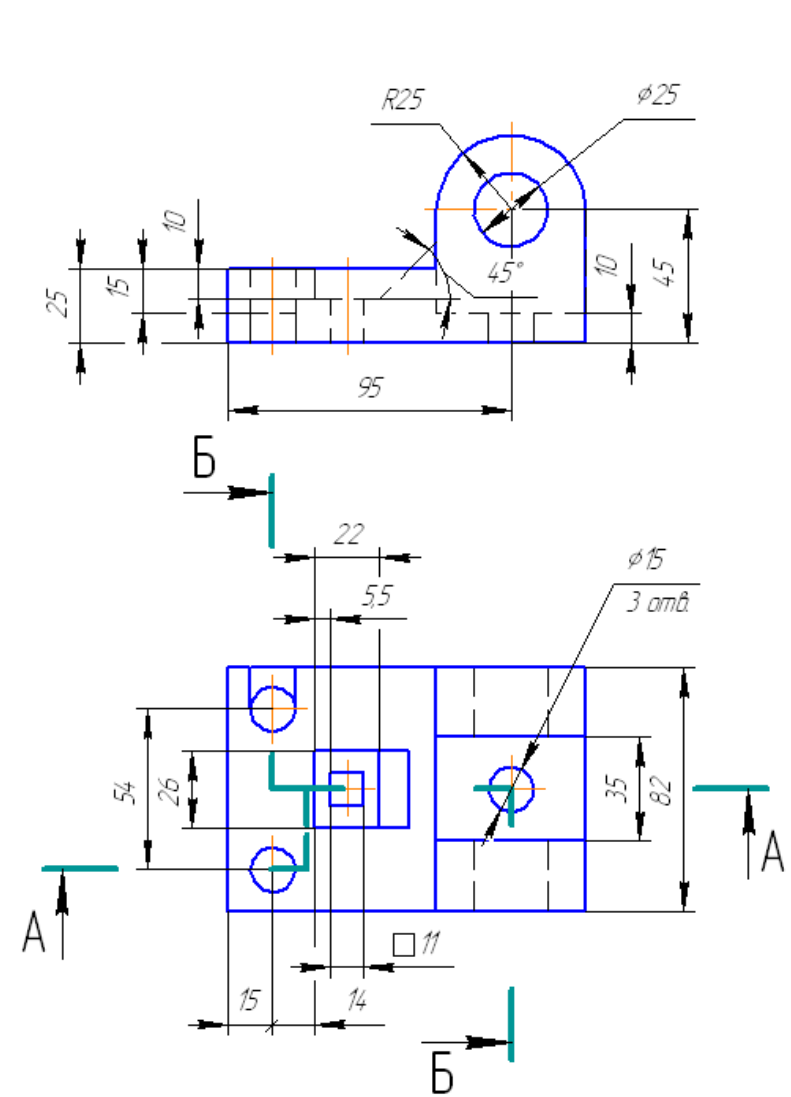

Вариант 15

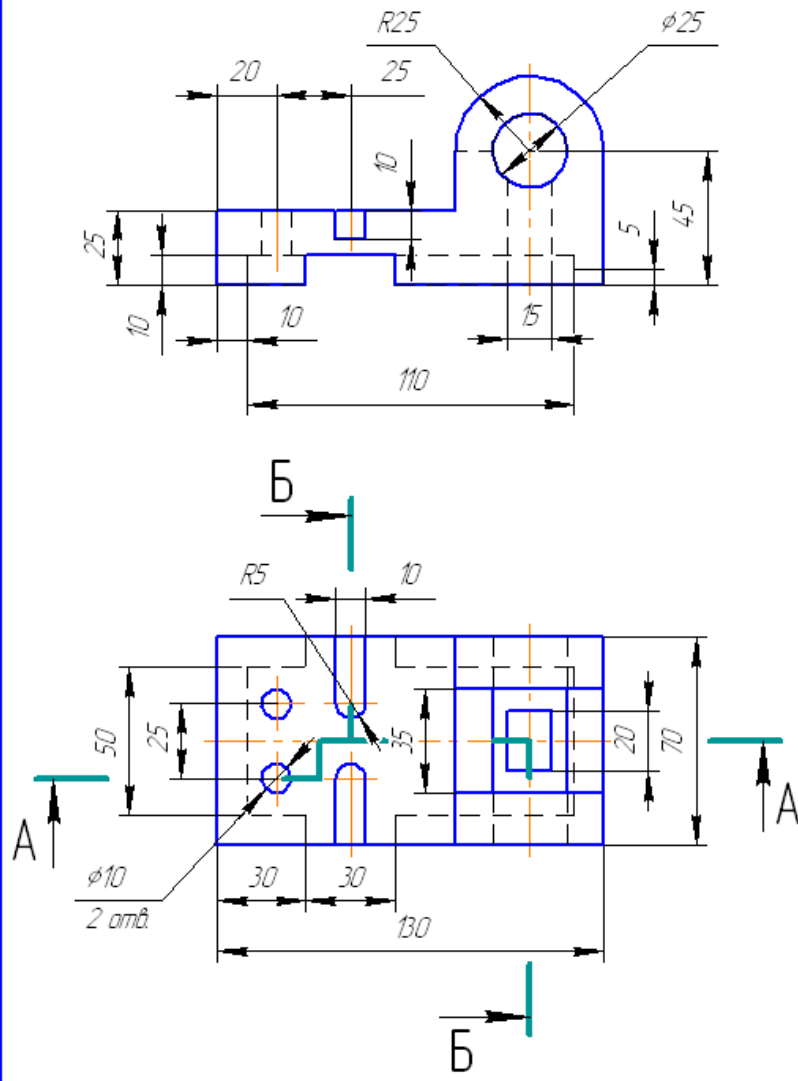

Вариант 16

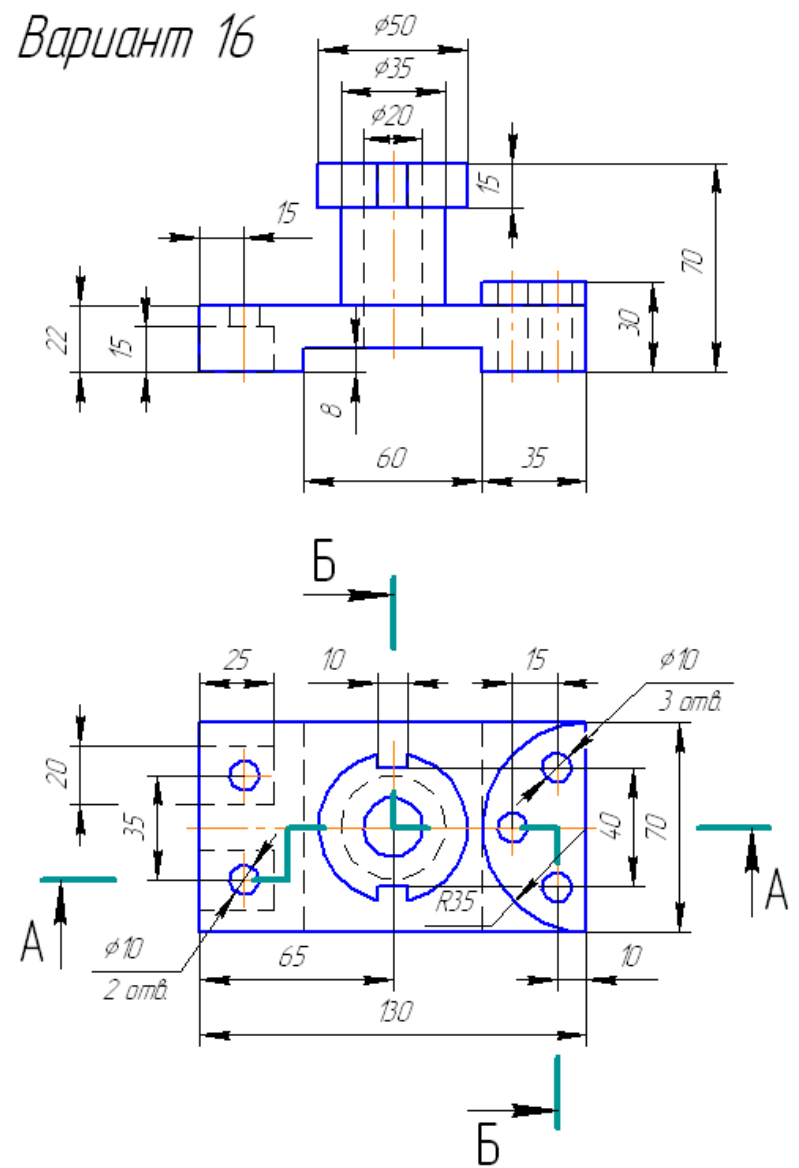

Вариант 17

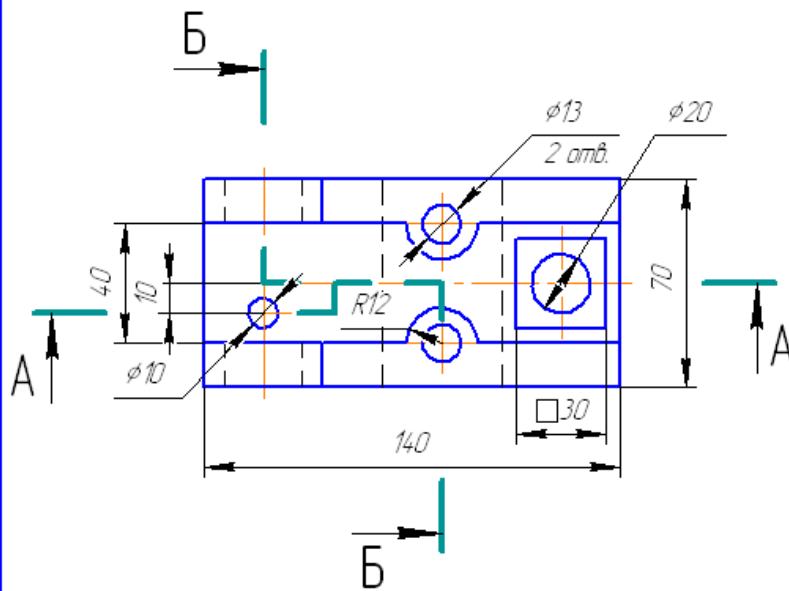
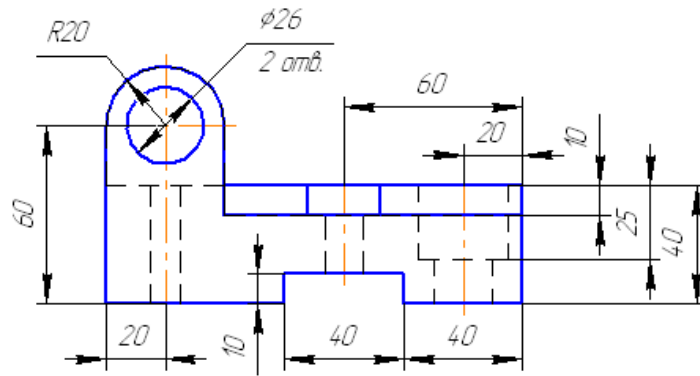

Вариант 18

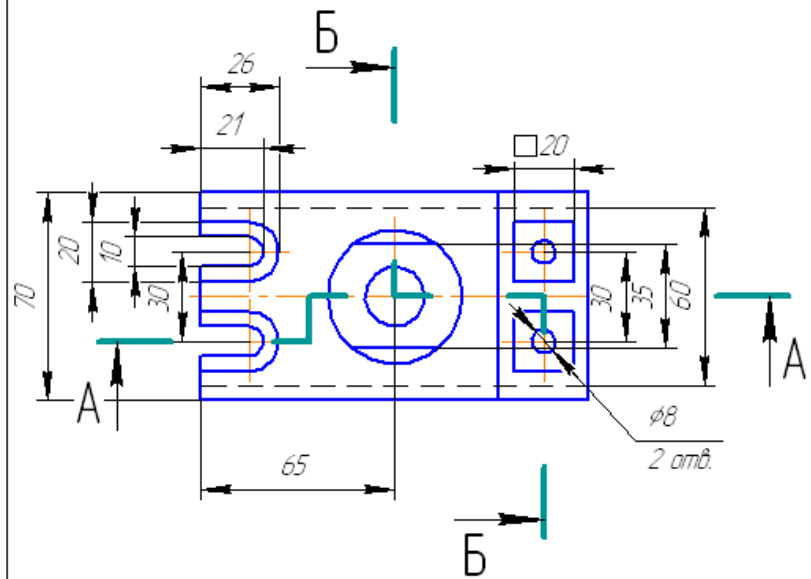
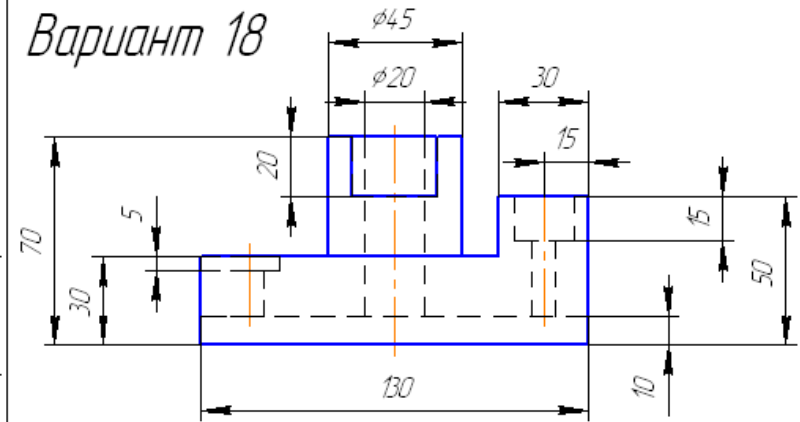

Вариант 19

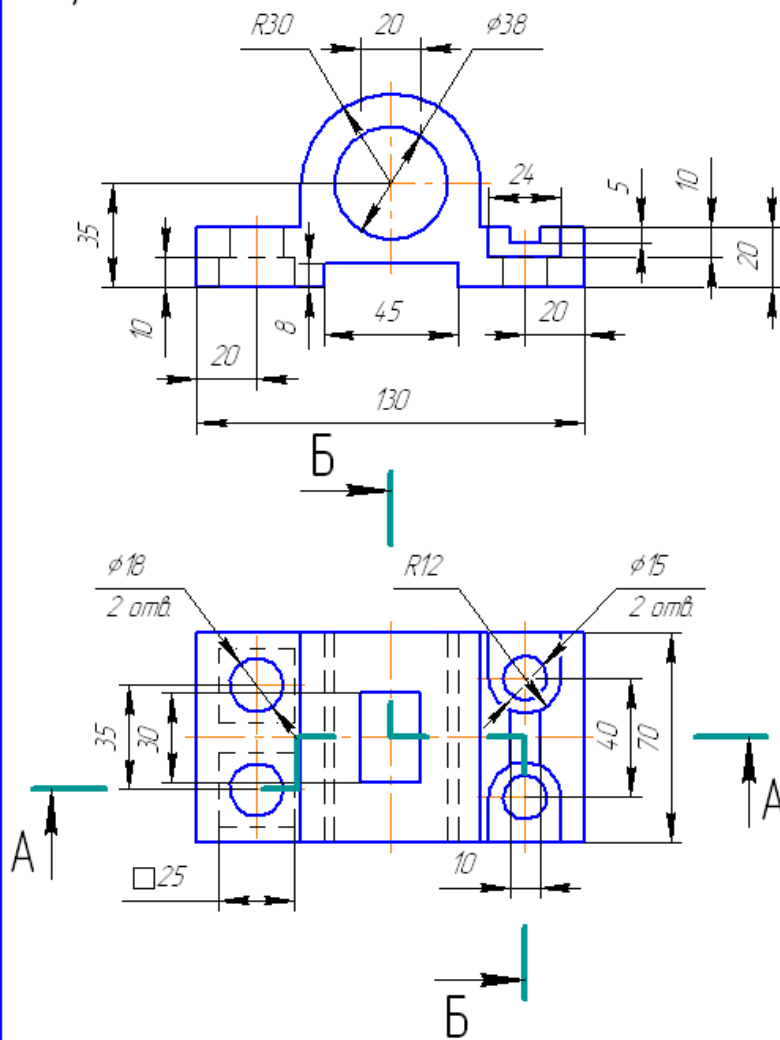

Вариант 20

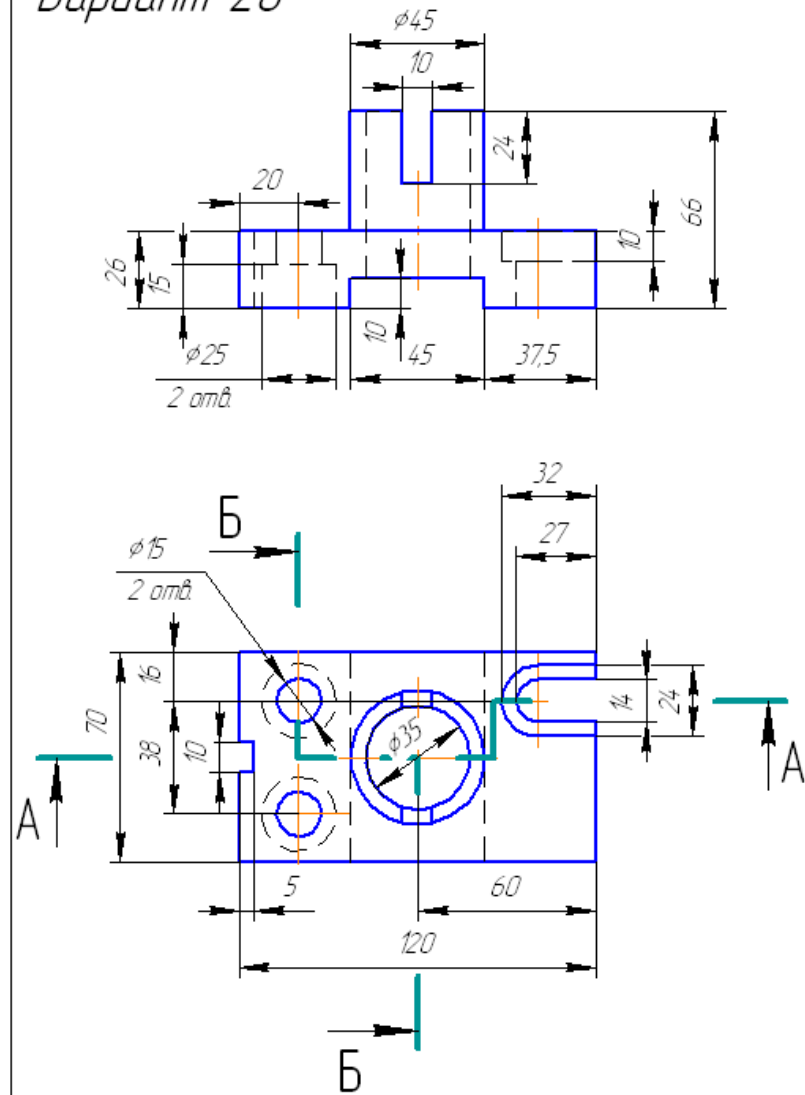

Вариант 21

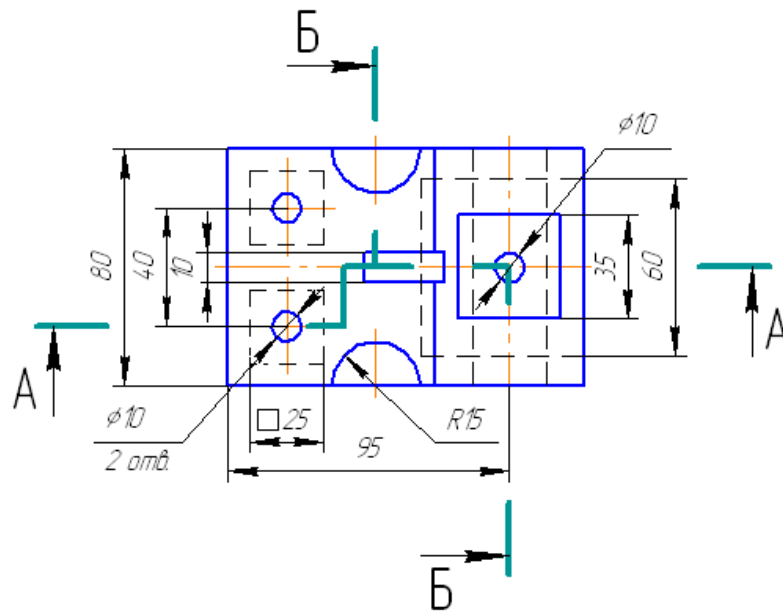
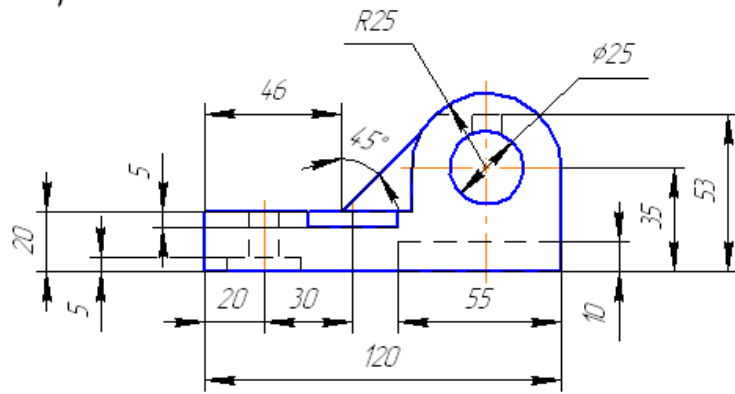

Вариант 22

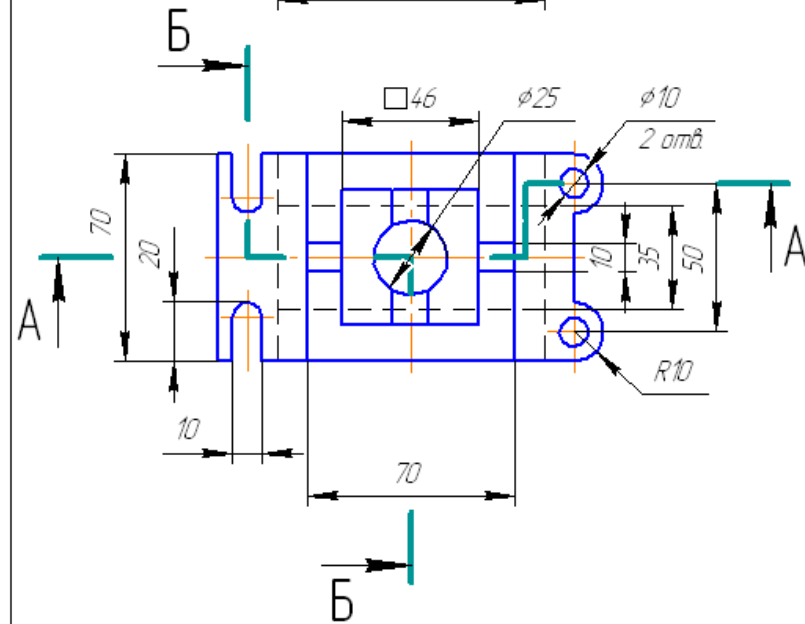
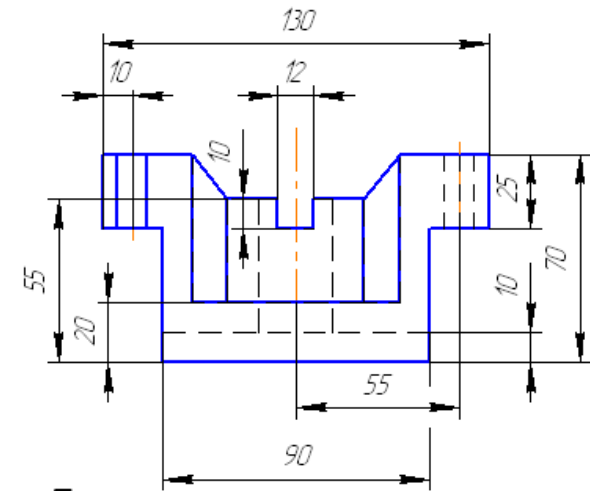

Вариант 23

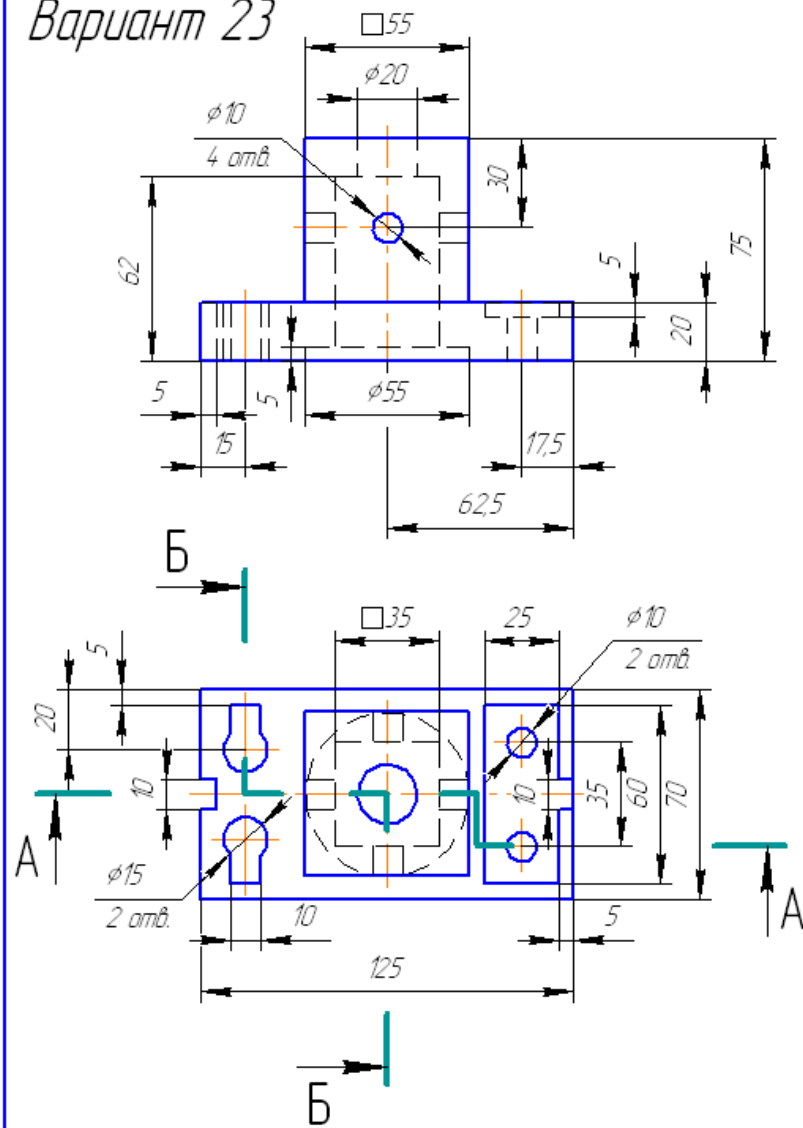

Вариант 24

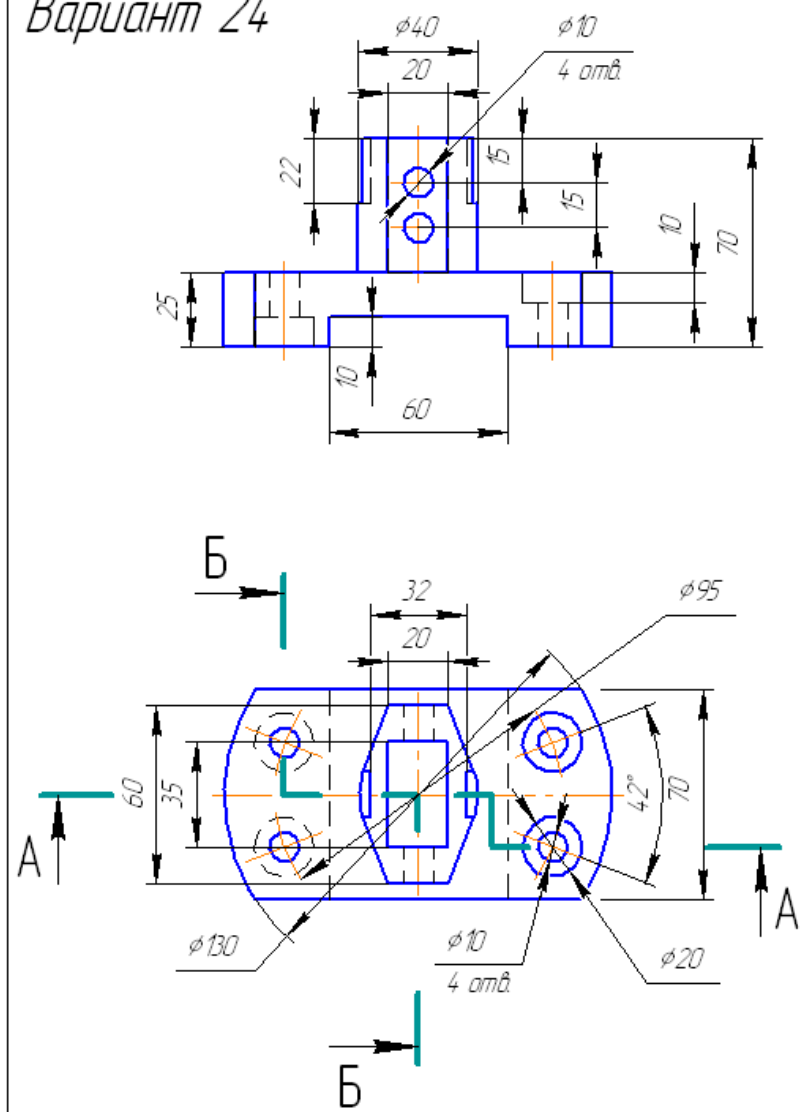

Вариант 25

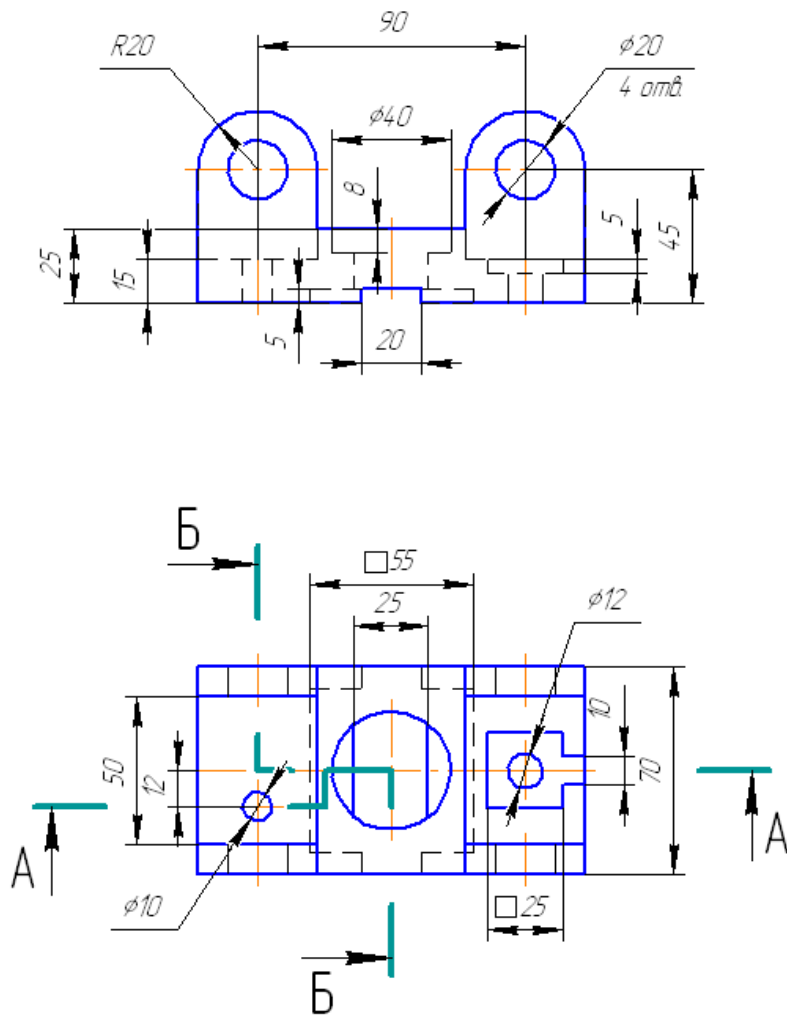

Вариант 26

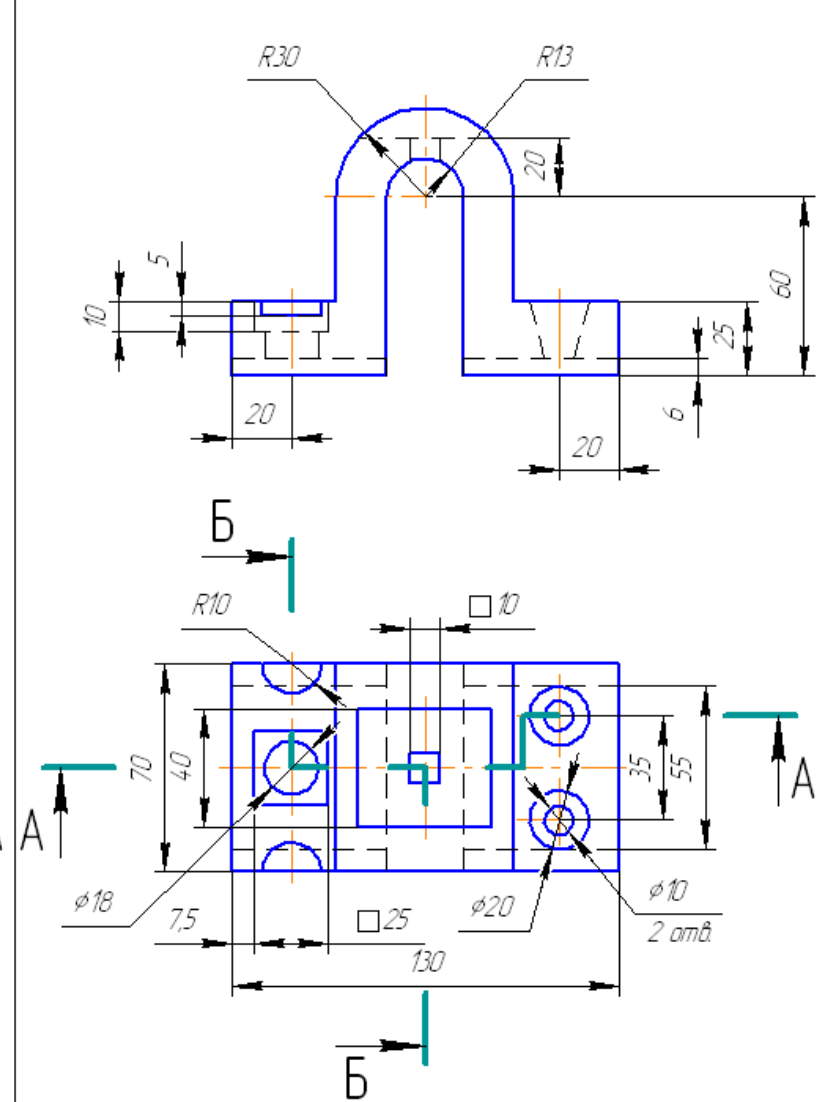

Вариант 27

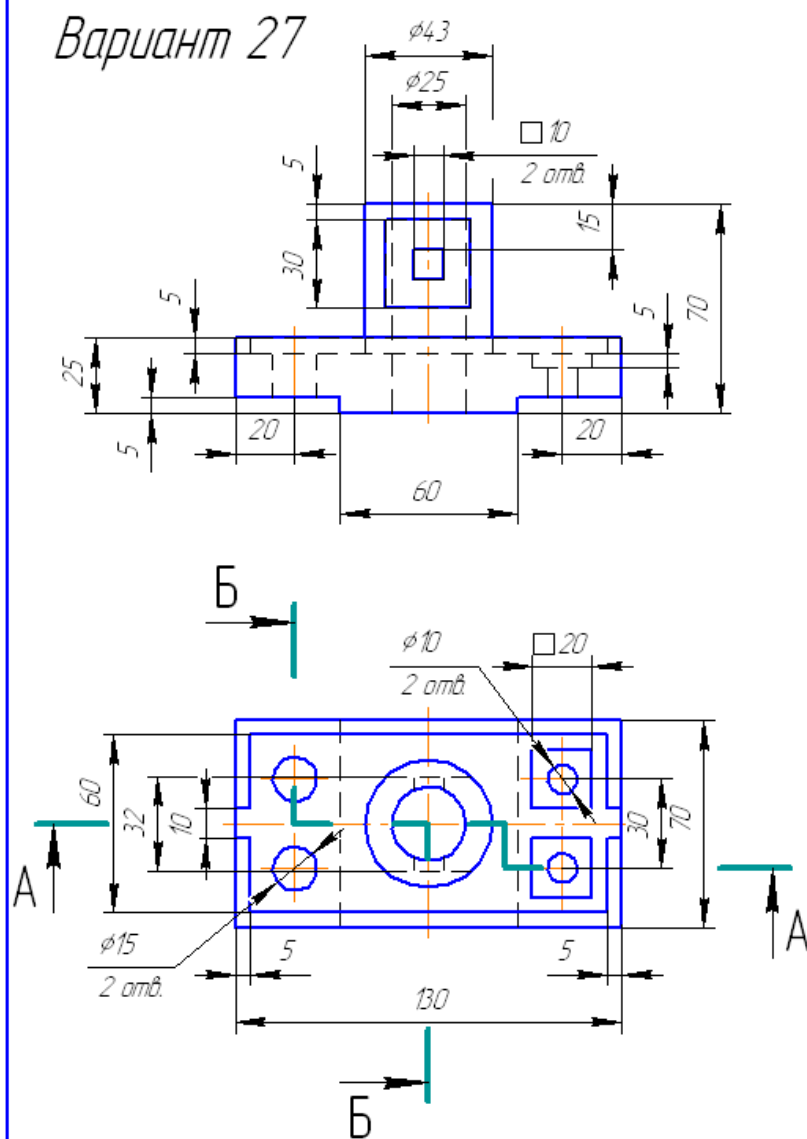

Вариант 28

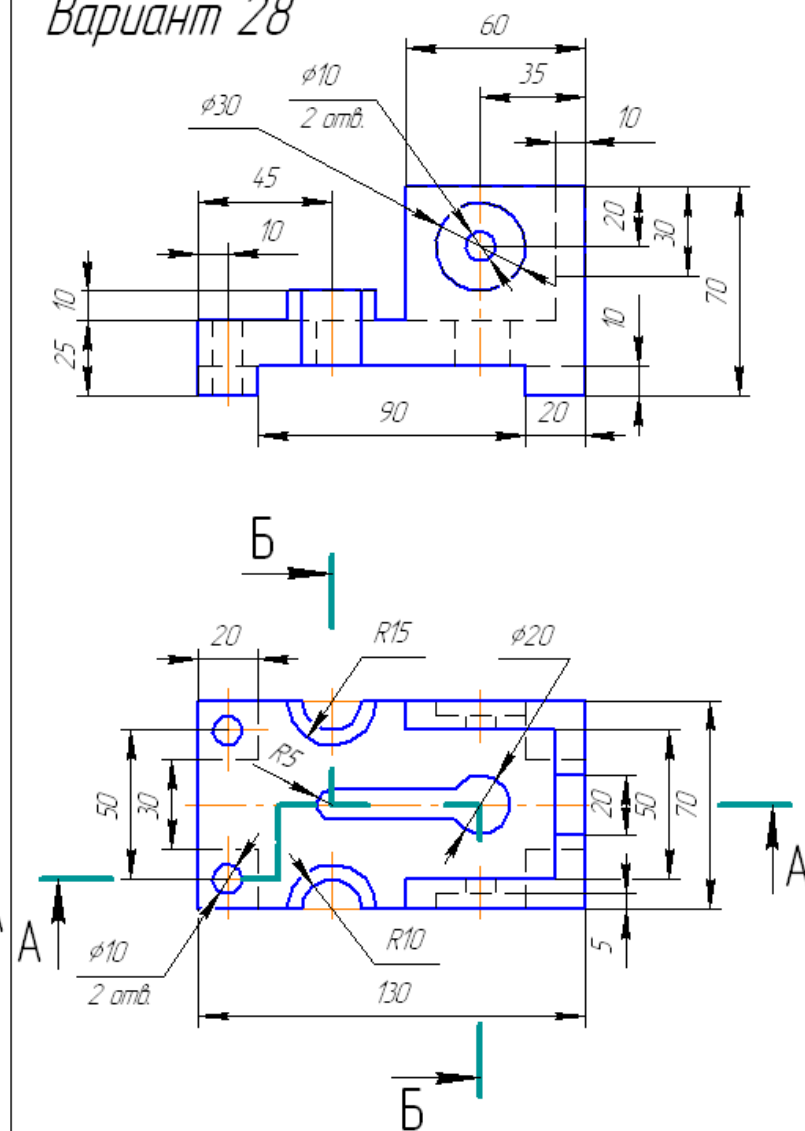

Вариант 29

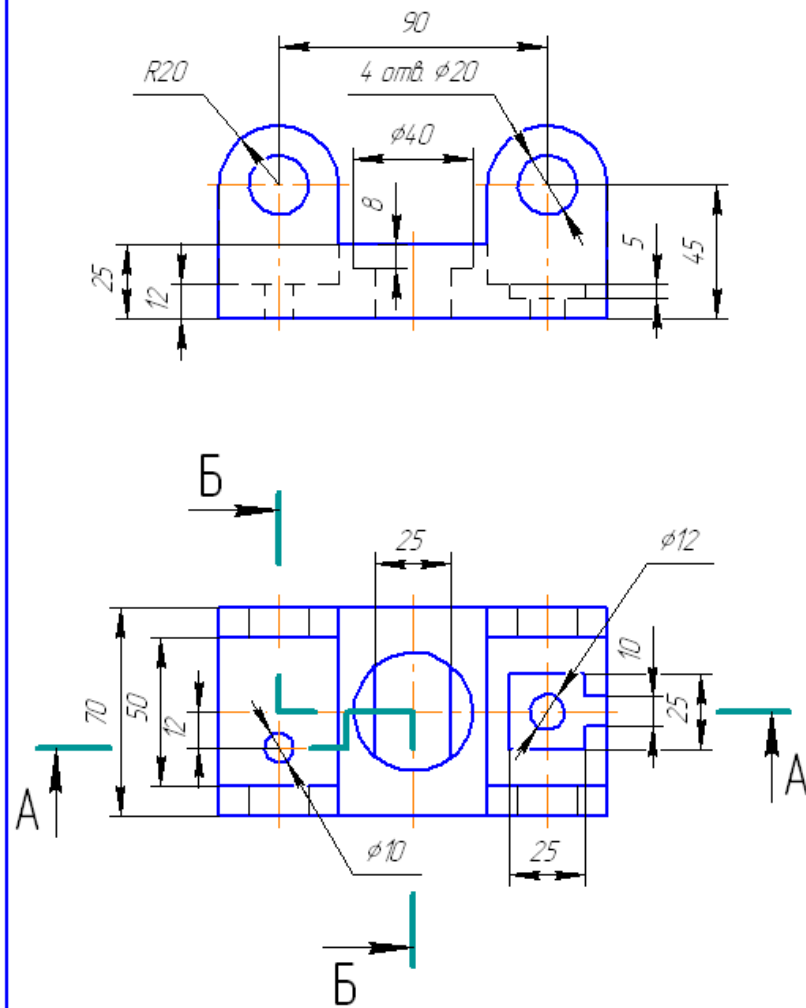

Вариант 30

